

WATERMARK

BROOKLYN, NEW YORK



Thea 45-1.2S-TA6

Wall Mounted Two Hole Lavatory Trim with Short Spout

- Flow Rate: 1.2 GPM Max @ 45-80 PSI
- Requires: SS-SHV1.2 Wall Lavatory Rough-In
- Lead-free brass construction
- Drain sold separately
- Professional installation recommended

Available in all finishes shown on the [Watermark Designs website](#)

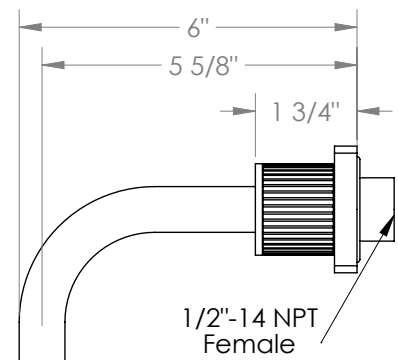
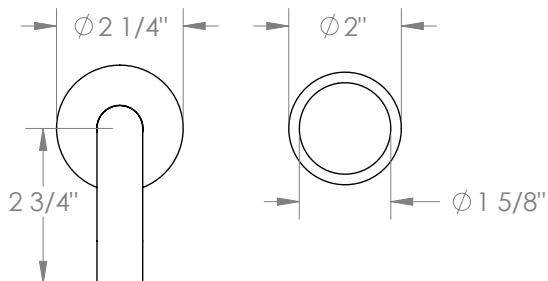

Meets the applicable requirements of ASME A112.18.1/CSA B125.1, entitled "Plumbing Supply Fittings".

Watermark Designs reserves the right to make revisions without notice to product specifications. All product dimensions are nominal.

Updated: 07/2025

350 Dewitt Ave. Brooklyn, NY 11207 USA | T: 1 718 257 2800 | F: 1 718 257 2144 | customerservice@watermark-designs.com