

WATERMARK

BROOKLYN, NEW YORK

Elements 21-8.2-KNE2

Deck Mounted Exposed Bath Set with Hand
Shower



- Some building codes require remote pressure balance valves for anti-scald
- 3/4"-14 NPS Male Deck Connection
- Recommended Mounting Hole: 1-3/8"
- 1/4 Turn Ceramic Cartridge
- All Solid Brass Construction
- Professional Installation Required

Available in all finishes shown on the [Watermark Designs website](https://www.watermark-designs.com)

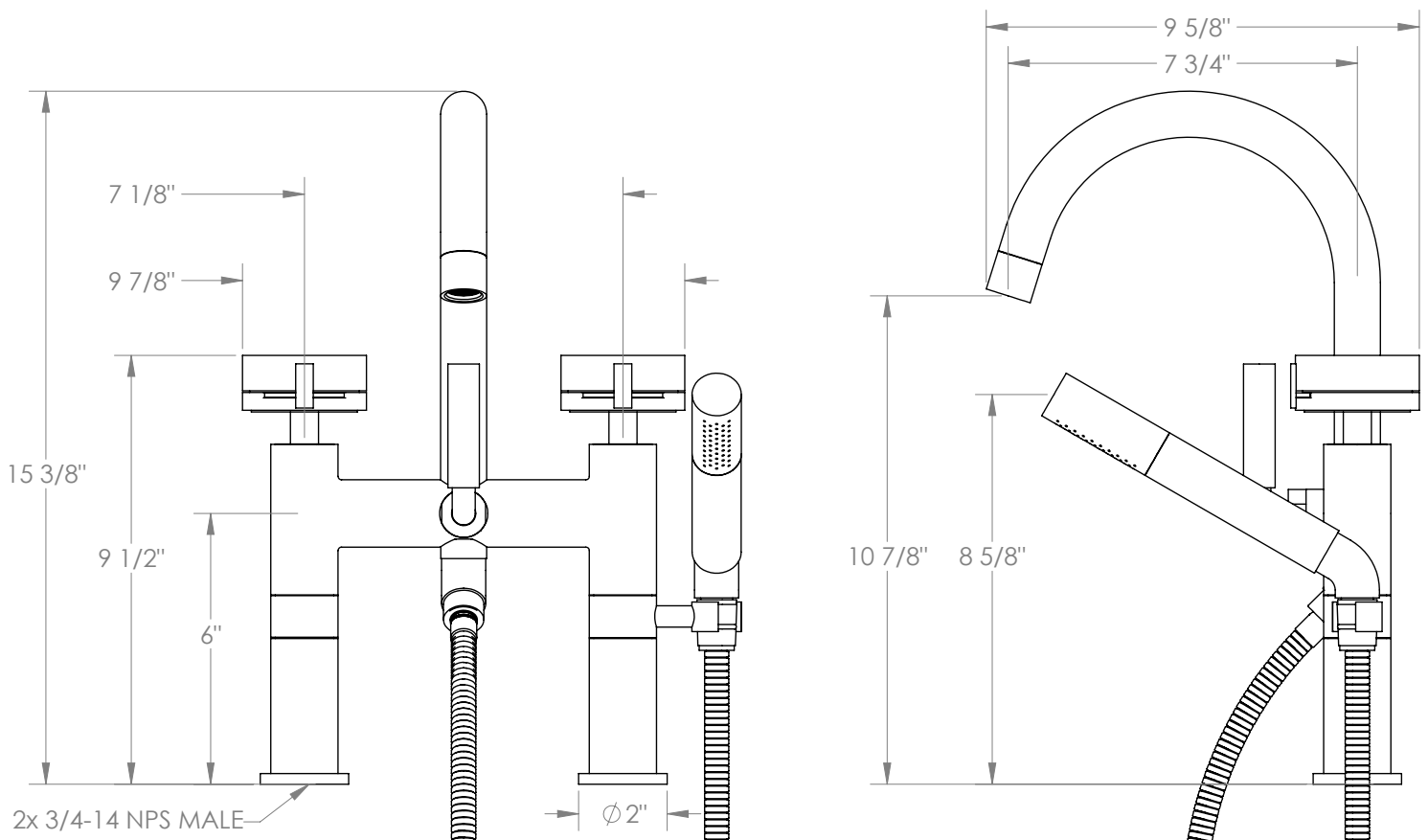

Meets the applicable requirements of ASME A112.18.1/CSA B125.1, entitled "Plumbing Supply Fittings".

Watermark Designs reserves the right to make revisions without notice to product specifications. All product dimensions are nominal.

Updated: 10/2024

350 Dewitt Ave. Brooklyn, NY 11207 USA | T: 1 718 257 2800 | F: 1 718 257 2144 | customerservice@watermark-designs.com