

WATERMARK

BROOKLYN, NEW YORK

Elements 21-2S-LKE3

Deck Mounted 3 Hole Lavatory Set



- Includes MPU5 soft touch drain with overflow
- Flow Rate: 1.2 GPM
- 1/2" Male Connection on Valves
- Recommended Mounting Hole: 1-3/8"
- 1/4 Turn Ceramic Cartridge
- All Lead-Free Brass Construction
- Professional Installation Required

Available in all finishes shown on the [Watermark Designs website](#)

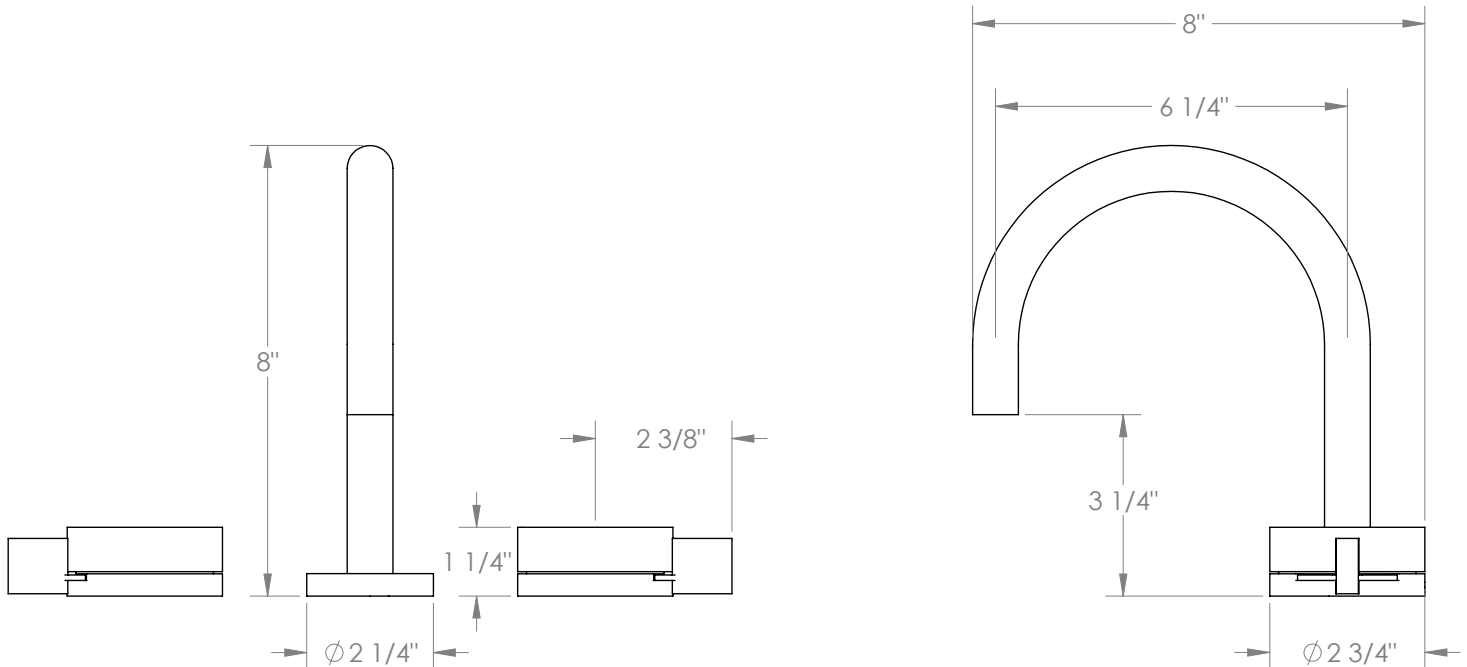

Meets the applicable requirements of ASME A112.18.1/CSA B125.1, entitled "Plumbing Supply Fittings".

Watermark Designs reserves the right to make revisions without notice to product specifications. All product dimensions are nominal.

Updated: 10/2024

350 Dewitt Ave. Brooklyn, NY 11207 USA | T: 1 718 257 2800 | F: 1 718 257 2144 | customerservice@watermark-designs.com