

WATERMARK

BROOKLYN, NEW YORK



Refinement 19-P90-LT6S

Wall Mounted Pressure Balance Shower Trim
with Diverter

- To be used with SS-PB85
- Optional item: EXT20
- Ceramic Mixing Cartridge with Integral Pressure Balancing
- All Solid Brass Construction
- Professional Installation Required

Available in all finishes shown on the [Watermark Designs website](#)

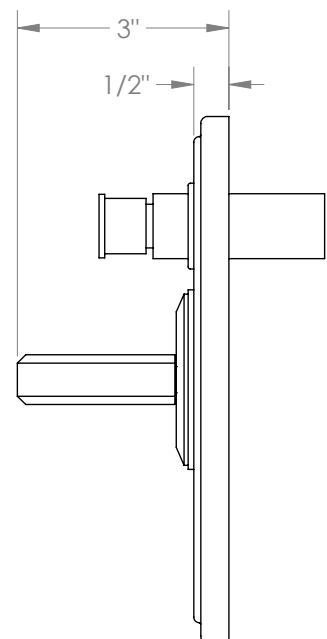
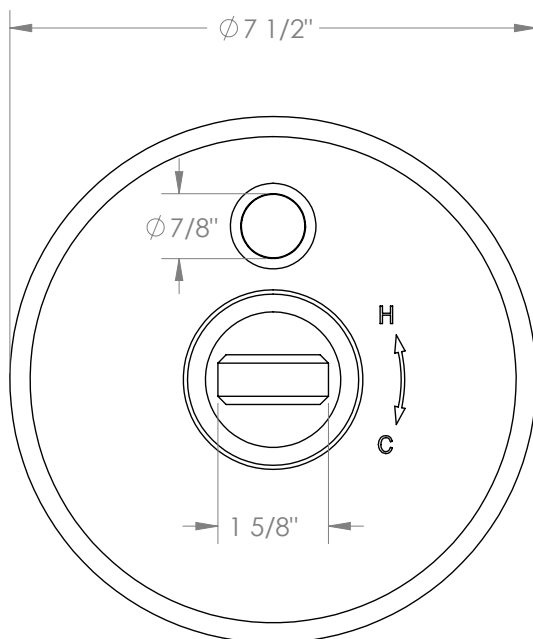

Meets the applicable requirements of ASME A112.18.1/CSA B125.1, entitled "Plumbing Supply Fittings".

Watermark Designs reserves the right to make revisions without notice to product specifications. All product dimensions are nominal.

Updated: 02/2026

350 Dewitt Ave. Brooklyn, NY 11207 USA | T: 1 718 257 2800 | F: 1 718 257 2144 | customerservice@watermark-designs.com