

# WATERMARK

BROOKLYN, NEW YORK

## Refinement 19-5-LT6S

Wall Mounted Three Hole Bath Set



- Requires concealed rough SS-506 or SS-THV2.2-26
- Some building codes require remote pressure balance valves for anti-scald
- Flow Rate: Full Flow
- 1/4 Turn Ceramic Cartridge
- All Solid Brass Construction
- Professional Installation Required

Available in all finishes shown on the [Watermark Designs website](#)

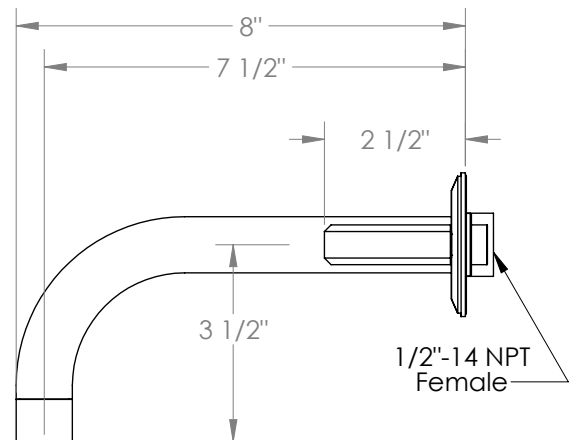
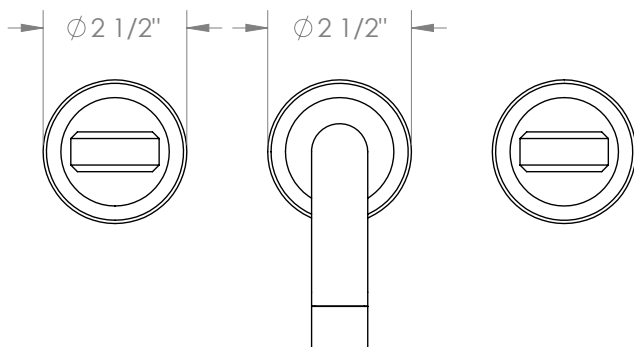

Meets the applicable requirements of ASME A112.18.1/CSA B125.1, entitled "Plumbing Supply Fittings".

Watermark Designs reserves the right to make revisions without notice to product specifications. All product dimensions are nominal.

Updated: 02/2026

350 Dewitt Ave. Brooklyn, NY 11207 USA | T: 1 718 257 2800 | F: 1 718 257 2144 | [customerservice@watermark-designs.com](mailto:customerservice@watermark-designs.com)